



**Features:**

- Universal AC input/ Full Range
- Energy Efficiency Level VI
- ErP Step 2 Compliant
- NRCAN Compliant
- Output Protections: OVP/SCP/OC/OTP
- No Load Power Consumption <0.21W
- 1 Year Warranty



Model	QADA-120-12	QADA-120-15	QADA-120-16	QADA-120-18	QADA-120-19	QADA-120-20	QADA-120-24	QADA-120-30	QADA-120-48	QADA-120-56
<b>Output Characteristics</b>										
DC Output	12V	15V	16V	18V	19V	20V	24V	30V	48V	56V
Rated Current	9.00A	8.00A	7.50A	6.60A	6.30A	6.00A	5.00A	4.00A	2.50A	2.14A
Ripple and Noise	±2% Vo @ Rated Load									
Load Regulation (Typ.)	±5%									
Transient Response (Typ.)	0.5mS for 50% Load Change									
Hold-up Time (Typ.)	10mS @ Rated Load									
Output Protection	Short Circuit, Over Voltage, Over Current, Over Temp									
Ferrite Core	Yes									
<b>Input Characteristics</b>										
Voltage Range	100VAC~240VAC									
Frequency Range	50Hz-60Hz									
Efficiency	DoE Level VI, Energy Star, ErP Stage 2, NRCAN & GEMS Level VI Certified									
AC Current (max)	1.6A									
Input Protection	Internal Primary Current Fuse, Inrush Limiting									
Leakage Current	3.5mA									
<b>Environmental Characteristics</b>										
Operating Temperature	0°C~40°C									
Operating Relative Humidity	20% RH to 80% RH									
Storage Temperature	-20°C~80°C, 10% RH to 90% RH									
Topology	Switching Flyback									
Dielectric Withstand	3000VAC Primary-Secondary									
EMI Conduction & Radiation	Compliance to EN55022 Class B									
Harmonic Current	Compliance to EN61000-3-2, 3									
EMS Immunity	EN61000-4-2, 3, 4, 5, 6, 8, 11									
<b>Characteristics</b>										
MTBF	300,000Hrs (25°C, Telecordia SR-332)									
Dimension (LxWxH)	168x66x39									
Weight	590g									

**PART NUMBER SYSTEM**

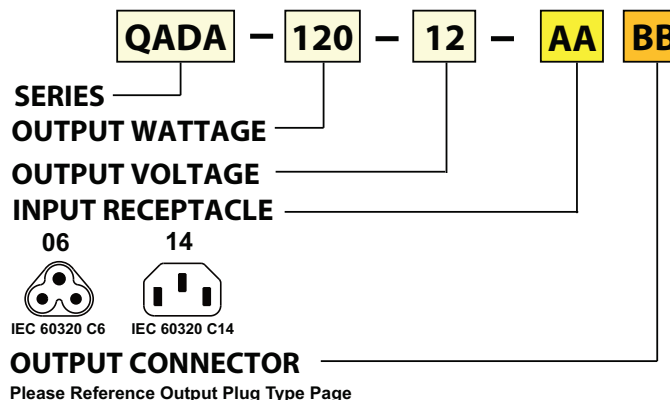

### MECHANICAL SPECIFICATIONS

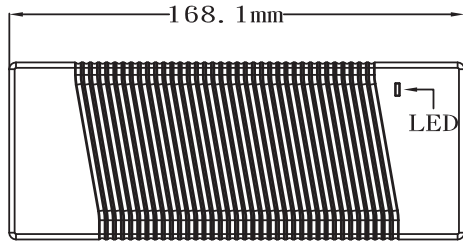

TOP-VIEW

UL1185 14AWG for 12 ~ 16V  
UL1185 16AWG for 18 ~ 24V  
UL1185 18AWG for 30 ~ 56V

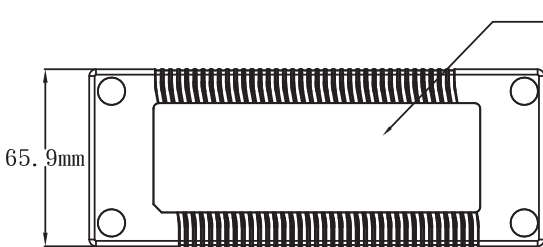
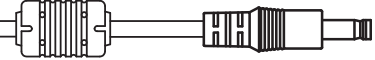

BOTTOM-VIEW

LABEL



SIDE-VIEW

1500±30  
Note: 12V = 1200mm

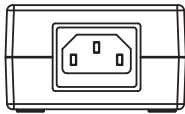

FRONT-VIEW

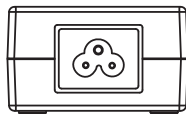

### DERATING CURVE

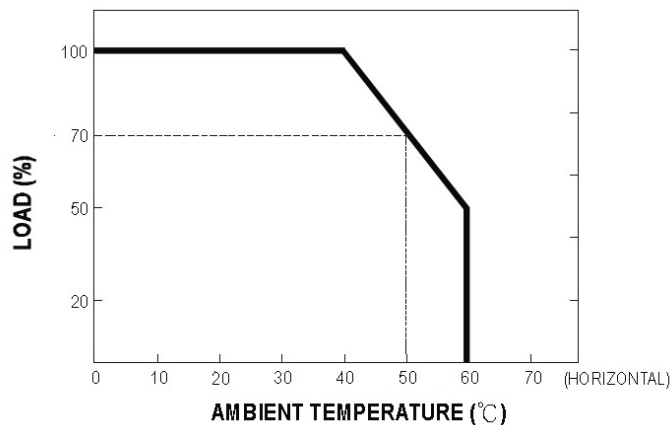

UNIT: mm